

Tolerances:-
 3 Decimal Points -+- 0.5mm
 2 Decimal Points -+- 1.0mm
 0 Decimal Points -+- 5mm

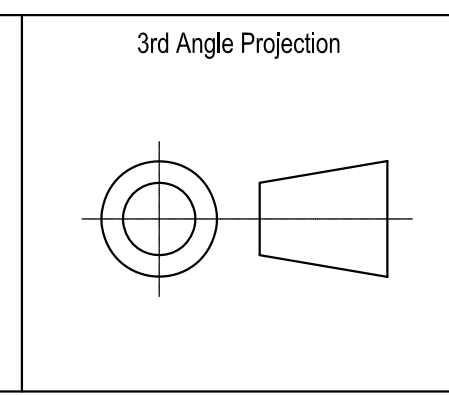

ECR	Rev	Drn	Description	Date	App
DRG Size	Date	ENG	DRAWN BY	CHKD	APPROVED
A0	XX	XX	XX	XX	XX
SCALE	Drawing Title		Drawing No.	REV	
n/a	MAXXflo EVO Lite SC35/201		XX	-	